





YPSILON

YPSILON &
YPSILON PLUS



6601

240693

Waschtisch-Einhebelmischer
ohne Zugstangenablauf

Wash Basin mixer

Kartusche: 35100 (6689-2)

Cartridge: 35100 (6689-2)

6601 VA(9065)

261603

mit Zugstangenablauf 1 1/4"

Ref. 9065 (PVC)

Wash Basin mixer with pop-up waste
1 1/4", Ref. 9065 ABS

6601 VA(1167)

261602

mit Zugstangenablauf 1 1/4"

Ref. 1167 (Messing)

Wash Basin mixer with pop-up waste
1 1/4", Ref. 1167 brass

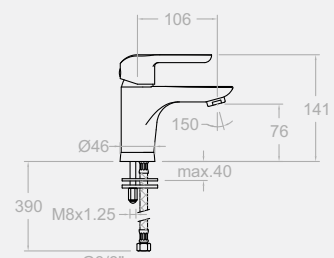

6610

257649

Hoher Waschtisch-Einhebel-
mischer

Wash Basin mixer

Kartusche: 35100 (6689-2)

Cartridge: 35100 (6689-2)

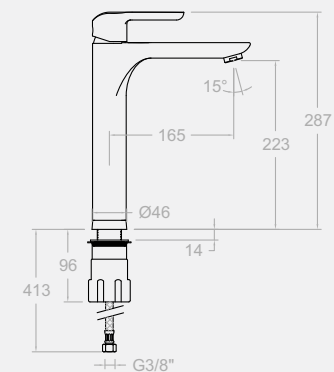



6603
240720

Bidet-Einhebelmischer
ohne Zugstangenablauf
Bidet mixer.

Kartusche: 35100 (6689-2)
Cartridge: 35100 (6689-2)

6603 VA(9065)
240729

mit Zugstangenablauf 1 1/4"
Ref. 9065 (PVC)
Bidet mixer with pop-up waste 1 1/4".Ref.
9065 ABS

6603 VA(1167)
240738

mit Zugstangenablauf 1 1/4"
Ref. 1167 (Messing)
Bidet mixer with pop-up waste 1 1/4".Ref.
1167 brass

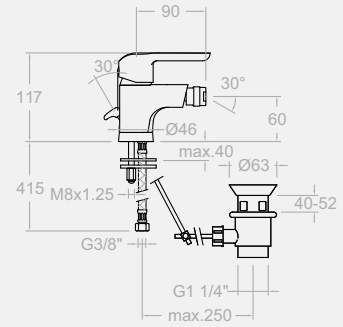

1219 L
197106

Ablauf 1 1/4" für Waschtisch und
Bidet mit System QUICK CLAC
(Metall/ABS)
1 1/4" Waste metal valve for basin and
bidet mixer. QUICK CLACK System



3790
198960

Siphon
Bottletrap



6622
253815

Wannenrand Einhebelmischer für
Friseurladen mit Brauseset
Bidet mixer with shower

Kartusche: 9000N
Cartridge: 9000N
6622S + 9989 SC + 9553 + 2950 C

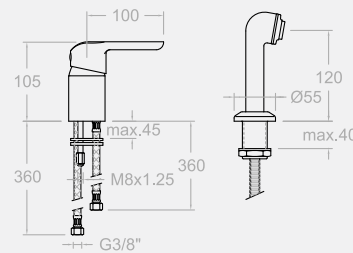

6622 S
251736

Wannenrand Einhebelmischer für
Friseurladen ohne Brauseset
Bidet mixer without shower

Kartusche: 9000N
Cartridge: 9000N

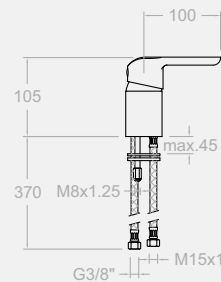



NEW

662002

66A300695

Waschtisch-Einhebelmischer
Unterputz mit Wandauslauf

Concealed Wash Basin mixer

Kartusche: 35100 (6689-2)

Cartridge: 35100 (6689-2)

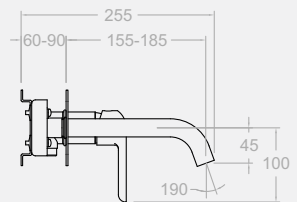
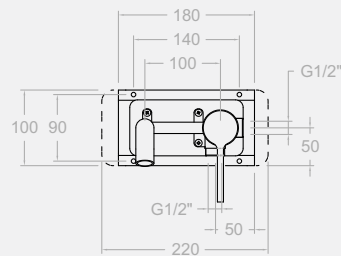

VORAUSSICHTLICH LIEFERBAR 1. JUNI
ESTIMATED AVAILABILITY JUNE 1^{FR}



NEW

662102

66A300694

Waschtisch-Einhebelmischer
Unterputz mit Wandauslauf

Concealed Wash Basin mixer

Kartusche: 35100 (6689-2)

Cartridge: 35100 (6689-2)

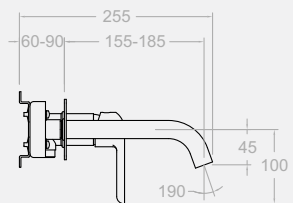
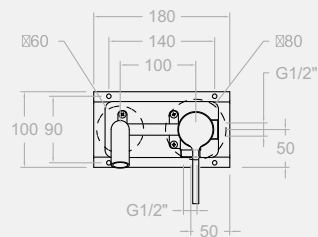

VORAUSSICHTLICH LIEFERBAR 1. JUNI
ESTIMATED AVAILABILITY JUNE 1^{FR}



6605 NS

257613

Einhebel-Wannenfüll- und Brause-
batterie ohne Brauseset

Bath and shower mixer

Kartusche: 35200 (6689)

Cartridge: 35200 (6689)

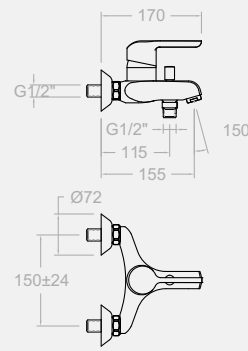

T1

6605 NT1

257622

Einhebel-Wannenfüll- und Brause-
batterie mit Brauseset

Bath and shower mixer with
shower kit

6605NS + 3553 T1

3553 T1 (3520 T1+3726+1128C)



T3

6605 NT3

261764

Einhebel-Wannenfüll- und
Brausebatterie mit Brauseset

Bath and shower mixer with
shower kit

6605NS + 5812 T3

5812 T3 (5840 T3+3726+1128C)

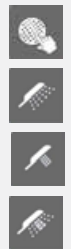

6608 NS

257631

Einhebel-Brausebatterie ohne
Brauseset

Shower mixer without shower kit

Kartusche: 35200 (6689)

Cartridge: 35200 (6689)

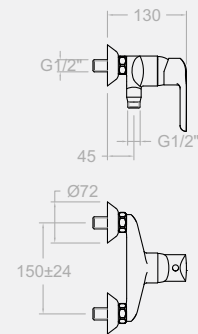

6608 NT1

257640

Einhebel-Brausebatterie mit
Brauseset

Bath and shower mixer with
shower kit

6608NS + 3553 T1

3553 T1 (3520 T1+3726+1128C)



6608 NT3

261766

Einhebel-Brausebatterie mit
Brauseset

Bath and shower mixer with
shower kit

6608NS + 5812 T3

5812 T3 (5840 T3+3726+1128C)

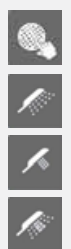





2 WEGE/WAY

6615 S

253788

Unterputz-Einhebel-Wafü- und Brausebatterie, 2 Wege

Concealed Shower mixer without shower and spout.

Kartusche: 9000N

Cartridge: 9000N

EBDN-2 ((K15 inklusive) + 6600-2)

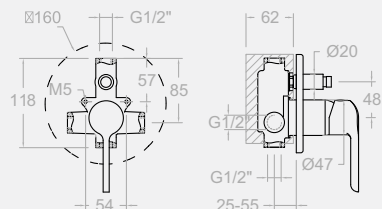

6615 B1

259476

Unterputz -Einhebel-Wannenfüll- und Brausebatterie mit

Brausekopfset und Auslauf
Concealed Shower mixer with shower and spout.

(6615 S+720+RP120+168)

EBDN-2 l/min	1 bar	3 bar	5 bar
1	14,7	24,9	32,1
2	13,6	23,1	29,6

UP-Verlängerungssatz / Extension set Ref. KAN15



720

156146

Wandarm 165 mm
Shower arm 165 mm



RP120

242070

Regenbrause (ABS) Ø 120 mm.
Antikalksystem

Chromed shower head of Ø120 mm. Limescale resistant



168

227409

Wandauslauf für Wanne 130 mm

Wall mounted cast spout 130 mm



1 WEG/WAY

6618 S

253806

Unterputz-Einhebel-Brausebatterie, 1 Weg

Concealed Shower mixer without shower and spout.

Kartusche: 9000N

Cartridge: 9000N

EDN-2 (K18 inklusive) + 6600-2)

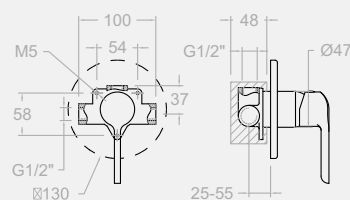

6618 A1

300027

Unterputz-Einhebel-Brausebatterie mit Brausekopfset

Concealed Shower mixer with shower and spout.

6618S + 720 + RP120

EDN-2 l/min	1 bar	3 bar	5 bar
	17,7	30,1	38,7

UP-Verlängerungssatz / Extension set Ref. KAN18



720

156146

Wandarm 165 mm
Shower arm 165 mm



RP120

242070

Regenbrause (ABS) Ø 120 mm.
Antikalksystem

Chromed shower head of Ø120 mm. Limescale resistant



1 WEG/WAY

NEW

661801 S *
66D300672

Unterputz-Einhebel-Brausebatte-
rie, 1 Weg

Concealed Shower mixer without
shower and spout.

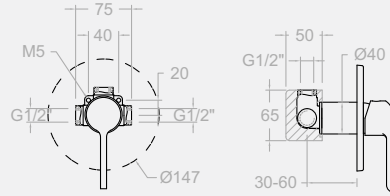

Kartusche: 35100 (6689-2)

Cartridge: 35100 (6689-2)

xx1801+6600N-35+R1

XX1801	1 bar	3 bar	5 bar
l/min	17	26	34

VORAUSSICHTLICH LIEFERBAR 1. JUNI
ESTIMATED AVAILABILITY JUNE 1^{FR}



2 WEGE/WAY

NEW

661502 S * 145,2 €
66C300673

Unterputz-Einhebel-Wafü- und
Brausebatte, 2 Wege

Concealed Shower mixer without
shower and spout.

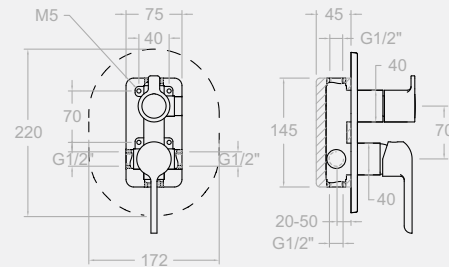

Kartusche: 35100 (6689-2)+ 4002

Cartridge: 35100 (6689-2) + 4002

xx1502+6600N-35+945100+R2

XX1502	1 bar	3 bar	5 bar
l/min	14	24	30
l/min	13	22	29

VORAUSSICHTLICH LIEFERBAR 1. JUNI
ESTIMATED AVAILABILITY JUNE 1^{FR}



3 WEGE/WAY

NEW

661503 S *
66C300674

Unterputz-Einhebel-Wafü- und
Brausebatte, 3 Wege

Concealed Shower mixer without
shower and spout.

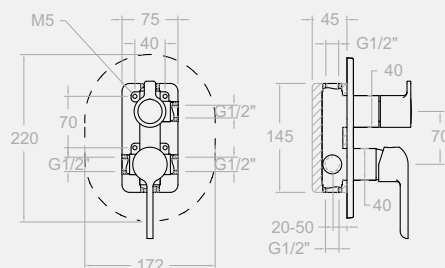

Kartusche: 35100 (6689-2)+ 4003

Cartridge: 35100 (6689-2) + 4003

xx1503+9400N-35+945100+R3

XX1503	1 bar	3 bar	5 bar
l/min	13	22	28
l/min	13	21	26
l/min	13	21	26

VORAUSSICHTLICH LIEFERBAR 1. JUNI
ESTIMATED AVAILABILITY JUNE 1^{FR}



6607 CC 117,0 €
240783

Spültisch-Wand-Einhebelmischer
mit schwenkbarem Rohrauslauf

Wall sink mixert with swivel
formed spout

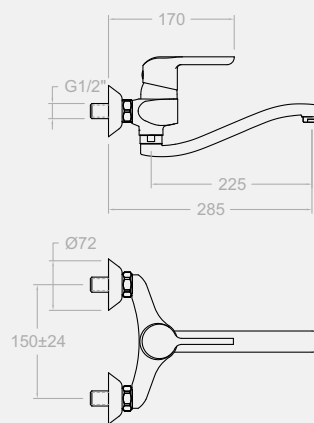

Kartusche: 9000N
Cartridge: 49000N



6617 CC
260025

Spültisch-Wand-Einhebelmischer
mit schwenkbarem Rohrauslauf

Wall sink mixert with swivel
formed spout

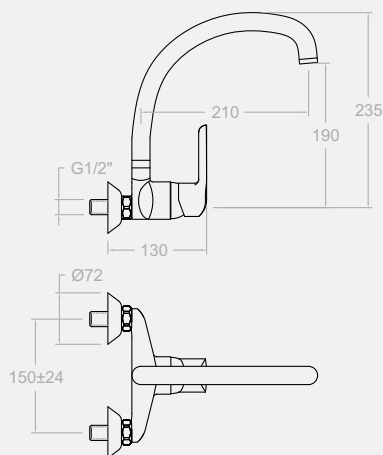

Kartusche: 35100 (6689-2)
Cartridge: 35100 (6689-2)



6636
261765

Spültisch-Einhebelmischer mit
schwenkbarem Rohrauslauf

Sink mixert with swivel formed
spout

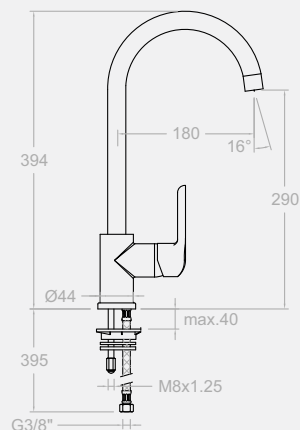

Kartusche: 35100 (6689-2)
Cartridge: 35100 (6689-2)











TECHNISCHE EIGENSCHAFTEN











- Kartuschen mit Keramikdichtscheiben Ø40mm und Ø35mm. Ausgestattet mit dem Termostop-Block-System, das durch die Blockierung des Hebels die maximale Warmwassertemperatur begrenzen kann und dem Wassersparsystem mittels 2-Phasen-Öffnung.
- Durchfluss bei 3 bar: Waschtisch, Bidet und Spültisch (von 9 bis 12 l/min), Dusche (von 12 bis 16 l/min), Wanne (20 l/min).
- Geräuschklasse 1. Geräuscherzeugung bei 3 bar < 20 dB.
- Zweischichtverchromung: 15 µm Nickel, 0,3 µm Chrom.
- Optimales Durchflussvolumen bei 3 bar. Benutzungsdruck zwischen 1 bis 5 bar.
- Druckdicht bei Werten ≤ 10 bar und Rückschläge von 25 bar.
- Heisswassertemperatur-Empfehlung von 55°C. Maximale Temperatur 64°C. Maximal 1 Stunde bei 90°C.
- Widerstandsfähigkeit bei Anti-Legionellen Temperaturschock.



 Kartusche Cartridge	35100 (6689-2)	252204	6601, 6603, 6606, 6610, 6617 CC, 6636 (ø35)
	35200 (6689)	251781	6605N, 6608N (ø35 "c2")
	9000N	238794	6607 CC, 6615, 6618, 6620, 6621, 6622(ø40)
 Begrenzungsring Limiter rings	ALT350	300062	6601, 6603, 6605N, 6606, 6608N, 6610, 6617 CC, 6636 (Temperatur)
	CLC	240441	6607 CC, 6615, 6618, 6620, 6621, 6622 (Durchfluss)
 Kartuschenmutter Cartridge nut	TSC350	253014	6636
	TSC353 (TSC8)	240909	6601, 6603, 6605N, 6606, 6608N, 6610, 6617 CC
	TSC3	167172	6615, 6618, 6620, 6621, 6622
	TSC7	240936	6607 CC
 Kartuschenringblende Cover	4980	252834	6636
	6680	240900	6601, 6603, 6605N, 6606, 6608N, 6610, 6617 CC
	5580	167177	6615, 6618, 6620, 6621, 6622
	6880	239991	6607 CC
 Hebel Handle	6600-35 (6600)	240648	6601, 6603, 6606, 6605N, 6608N, 6610
	6600I-35 (6600I)	260295	6617 CC
	6600IFV-35	300108	6636
	6600-9N (6600-2)	240657	6607 CC, 6615, 6618, 6620, 6621, 6622
 Abdeckkappe Cold water index	DT1-CN	252825	6601, 6603, 6605N, 6606, 6607 CC, 6608N, 6610, 6615, 6617 CC, 6618, 6620, 6621, 6622, 6636

TECHNICAL CHARACTERISTICS

- Ceramic mixer tap cartridge: Ø35mm for washbasins, bidets, showers, bath-shower, vertical sinks and wall-mounted sinks. Ø40mm for wall-mounted sinks, vertical sinks, embedded showers, bath-showers and embedded washbasins.
- Ceramic mixer tap cartridge with Termostop Block System limiting the maximum temperature of hot water and a water saving system (S2-C2) by a two-phase opening lever. The cold central opening system (S3-C3) is available in some models.
- Flow rate at 3 bars: Washbasin, bidet and sink (from 9 to 12 l/min.); Shower (from 12 to 16 l/min.); and Bath (≥20 l/min.)
- Comfortable performance as regards reliability, sensitivity and steadiness in the temperature selection.
- Acoustic level at 3 bars: < 20 dB.
- Chrome-plated brass: 15 microns thick of nickel, 0.3 microns of chrome.
- Working pressure between 1-5 bars, recommended: 3 bars. It resists static pressures ≤ 10 bars and water hammers of 25 bars.
- Recommended temperature for the hot water: 55 °C. Maximum working temperature: 65 °C. Maximum: 1h at 90 °C.
- Resistant to thermal and anti-Legionella chemical shocks.
- ACS health compliance certificate.

 Luftsprudler Aerator	1510	154228	6606
	1522	250719	6601, 6603, 6607 CC, 6610, 6617 CC, 6620
	1534	252879	6605N
	1524	259845	6621
	1538	251988	6636
 Bidetgelenk Bidet Knee	1540	143419	6603
 Sockel Base	1830	252960	6636
	6630P	251790	6601, 6603, 6606
	6630M	260340	6610
 Flexibler Edelstahlschlauch Flexible connection	224	120826	6603, 6606
	229A	227085	6601, 6636 (kalt/cold)
	229R	227076	6601, 6636 (warm/hot)
	232	261963	6610
	256	226248	6622
 Kettenöse Pop-up chain holder	PC	173022	6601, 6603
 Verstärkungssockel Reinforcement base	BRF	162429	6636 (f. Spültisch)
 Umsteller Diverter	3375	217410	6605N
	1570	154166	6615 (f. UP-Einhebelmischer)
 Rückflussverhinderungsventil Check valve	ARD 15	181680	6605N, 6608N

Stutzen Shower raccord 	RD01P (RD PVC)	242106	6608N (f. Brauseschlauch-anschluss)
Sitz Seat 	AGM-2I	252816	6605N, 6607 CC, 6608N, 6617 CC
Mutter Seat nut 	T 3/4	160220	6605N, 6607 CC, 6608N, 6617 CC
Zierblende Plate 	1325	167127	6605N, 6607 CC, 6608N, 6617 CC
	1334	252951	6605N, 6607 CC, 6608N, 6617 CC (Zierblende + S-Anschluss/plate+eccentric)
S-Anschluss Eccentric 	E 1/2 3/4	160248	6605N, 6607 CC, 6608N, 6617 CC
Auslauf Spouts 	CC17	253104	6617 CC
	CC07 /11	230505	6607 CC
	CE08Y	251799	6606
	C4420	208410	6620
	C3720	199374	6621
	C2402	300036	6636
Schwenkgelenk f. Rohrauslauf Nexus spout 	1400	222414	6607 CC y 6606
	1430	241269	6617 CC
	1450	252933	6636
Zierblende Wall plate 	1150	162494	6615
	1160	162501	6618
	K20	251934	6620
	1162	261527	6621 (Einhebelmischer/spout)
	1163	261528	6621 (Auslauf/ body)
Handbrause Hand shower 	9553	199833	6622 (f. Friseurladen)
Brauseschlauch- Halterung Wallbracket 	9989 SC	200148	6622
Brauseschlauch Flexible hose 	2950C	159759	6622
	1128C	208176	6605N, 6608N

UP-Einbaukörper- Einhebelmischer Concealed bodies 	EDN-2	205188	6618
	EBDN-2	205179	6615
Montageset Fixing set 	BMA	187080	6601, 6603, 6622 y 6606
	BAC1	300039	6636
	BAC6610	300045	6610